

Track System Specification

MT20G

— MagTrack 20 series



◎ Basic Parameters

- Material: AL6063-T5, spraying surface
- Coating: Black (RAL9005)/White (RAL9003)
- Length: 110mm,220mm,440mm optional
- IP grade: IP20
- CCT: 2700K,3000K,4000K
3000K-4000K-5000K optional
- CRI: 90
- SDCM: <3 Step (ANSI)
- Beam angle: 30°,55°
- Light efficiency: 73 LM/W,68 LM/W
- Input voltage: DC24V-48V,DC48V
- Lighting direction: Downward
- Dimming method: Non-dimming,DALI-2,Tuya Bluetooth,CASAMBI
- Application: Indoor
- Certification: CE,UKCA,ROHS,Reach
- Warranty: 5 years

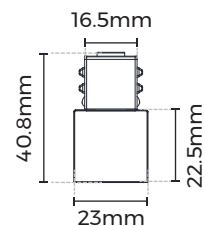

◎ Product mechanical data

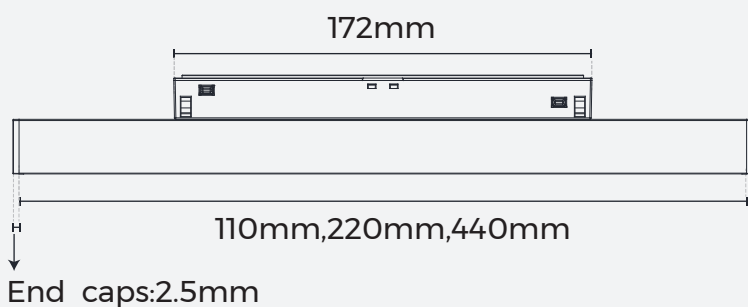

© Luminaire Parameters

Version	Model	Length	Input Voltage (V)	Max. Current (A)	Type Power (W)	Max. Power (W)	CRI	Beam Angle	Lumen @4000k (LM)
Normal	MT20G	110mm [0.36ft]	24-48VDC	0.25-0.125	6.0 [16.67W/ft]	6.6 [18.33W/ft]	>90	30°	440 [1220LM/ft]
								55°	410 [1140LM/ft]
		220mm [0.72ft]	24-48VDC	0.5-0.25	12.0 [16.67W/ft]	13.2 [18.33W/ft]	30°	880 [1220LM/ft]	
								55°	820 [1140LM/ft]
		440mm [1.44ft]	48VDC	0.50 [0.35A/ft]	24.0 [16.67W/ft]	26.4 [18.33W/ft]	30°	1750 [1220LM/ft]	
								55°	1630 [1140LM/ft]
3 CCT tunable (Dial switch)	MT20G	110mm [0.36ft]	24-48VDC	0.25-0.125	6.0 [16.67W/ft]	6.6 [18.33W/ft]	>90	30°	450 [1250LM/ft]
								55°	420 [1165LM/ft]
		220mm [0.72ft]	24-48VDC	0.5-0.25	12.0 [16.67W/ft]	13.2 [18.33W/ft]	30°	900 [1250LM/ft]	
								55°	840 [1165LM/ft]
		440mm [1.44ft]	48VDC	0.50 [0.35A/ft]	24.0 [16.67W/ft]	26.4 [18.33W/ft]	30°	1800 [1250LM/ft]	
								55°	1680 [1165LM/ft]

Note:

1. Test Basis: Output data are based on tests for Ra 90, 4000K luminaires.

- Normal Versions:

· 2700K: Light efficiency & luminous flux = 4000K value × 0.85

· 3000K: Light efficiency & luminous flux = 4000K value × 0.9

- 3-CCT Tunable (Dial Switch) Versions:

· 3000K: Light efficiency & luminous flux = 4000K value × 0.9

· 5000K: Light efficiency & luminous flux = 4000K value × 0.95

· Special Note: 1200mm/24W models are exclusive to 48V.

2. Tolerance: Output data tolerance is within ±10%.

3. Data Nature: Values are typical (not guaranteed minimum)

© Optical Parameter

- Normal

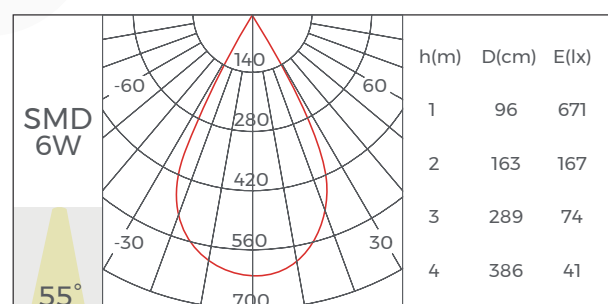
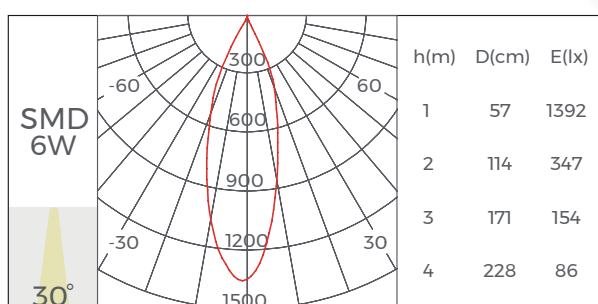

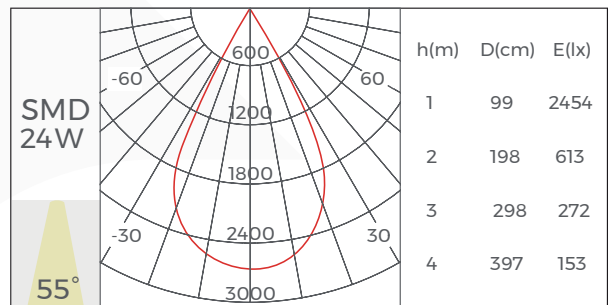
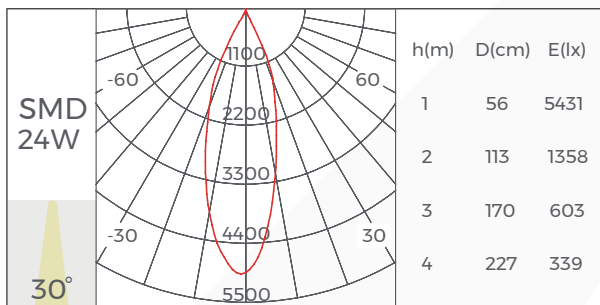
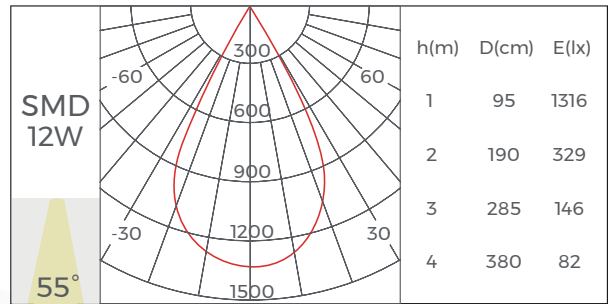
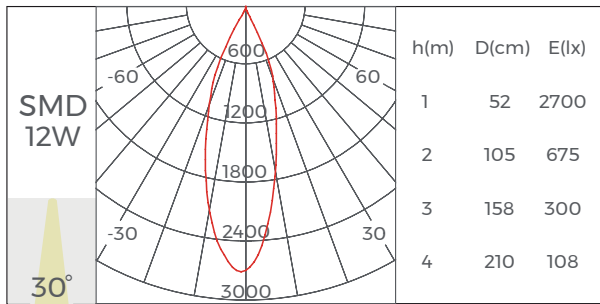

- 3 CCT tunable(Dial switch)

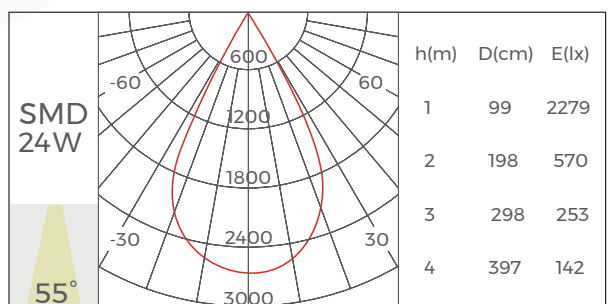
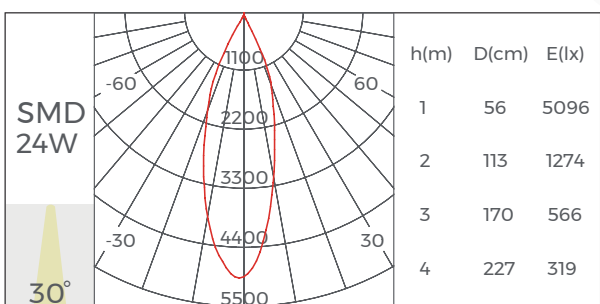
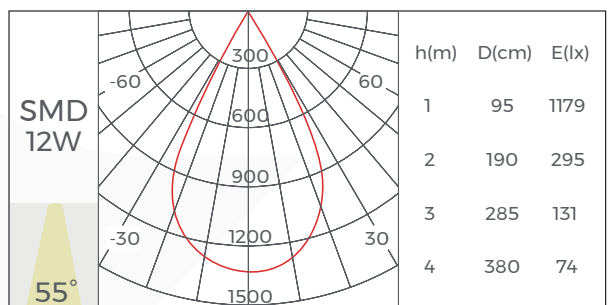
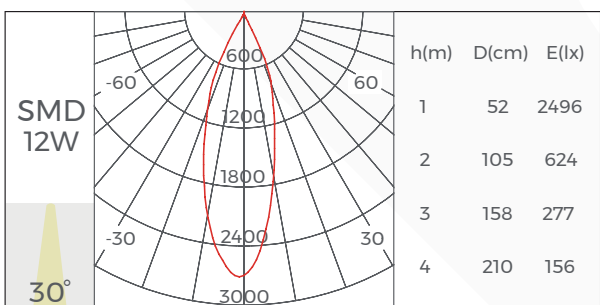
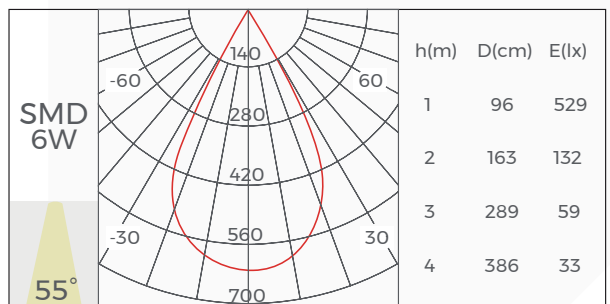
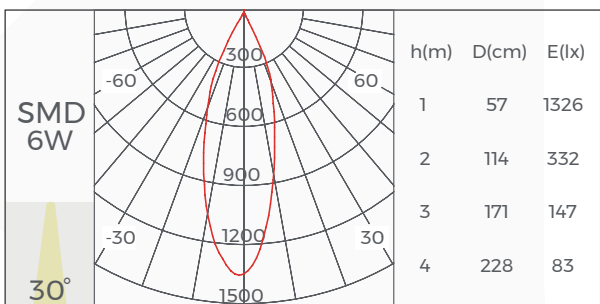

© MagTrack 20 Application

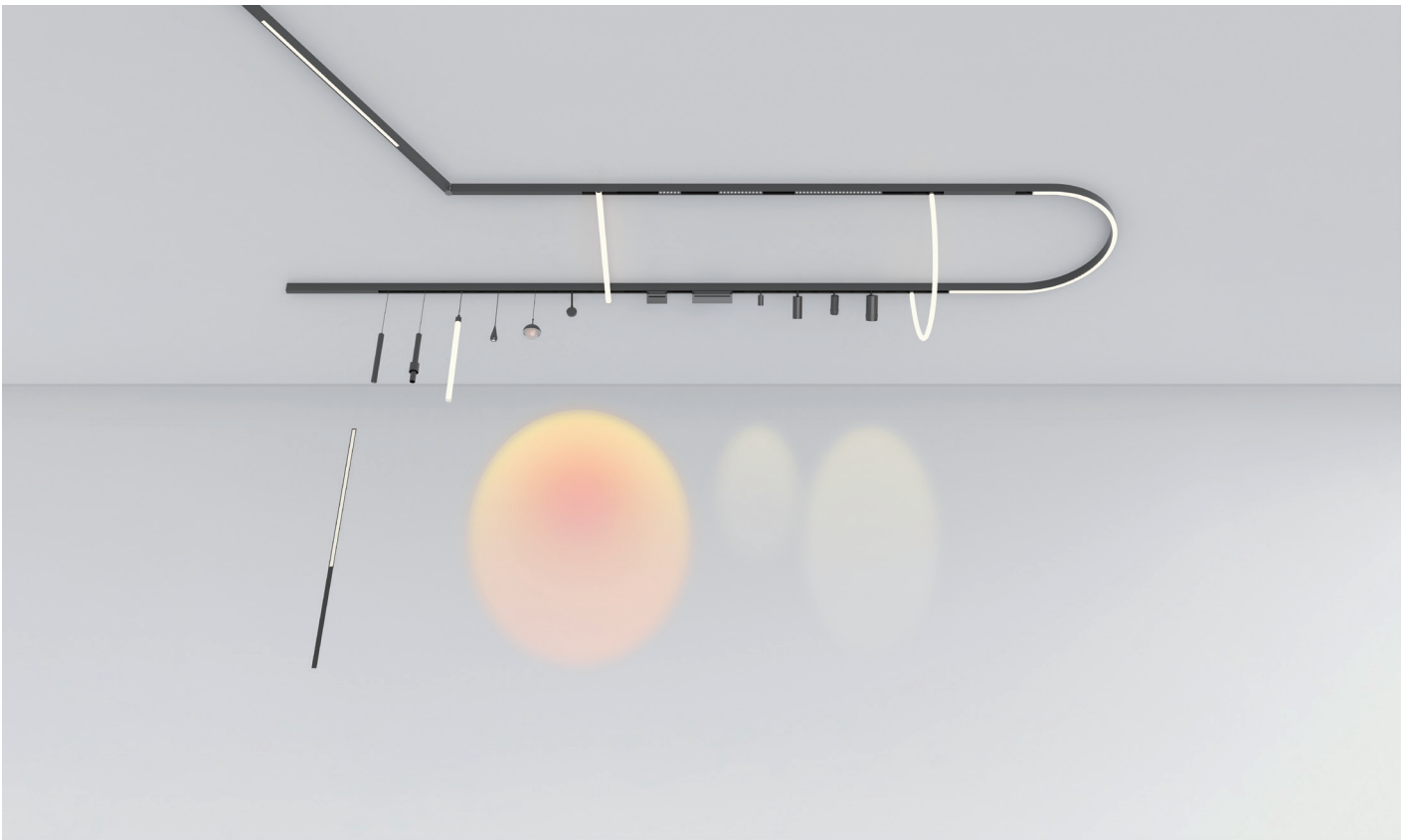

© Points to note

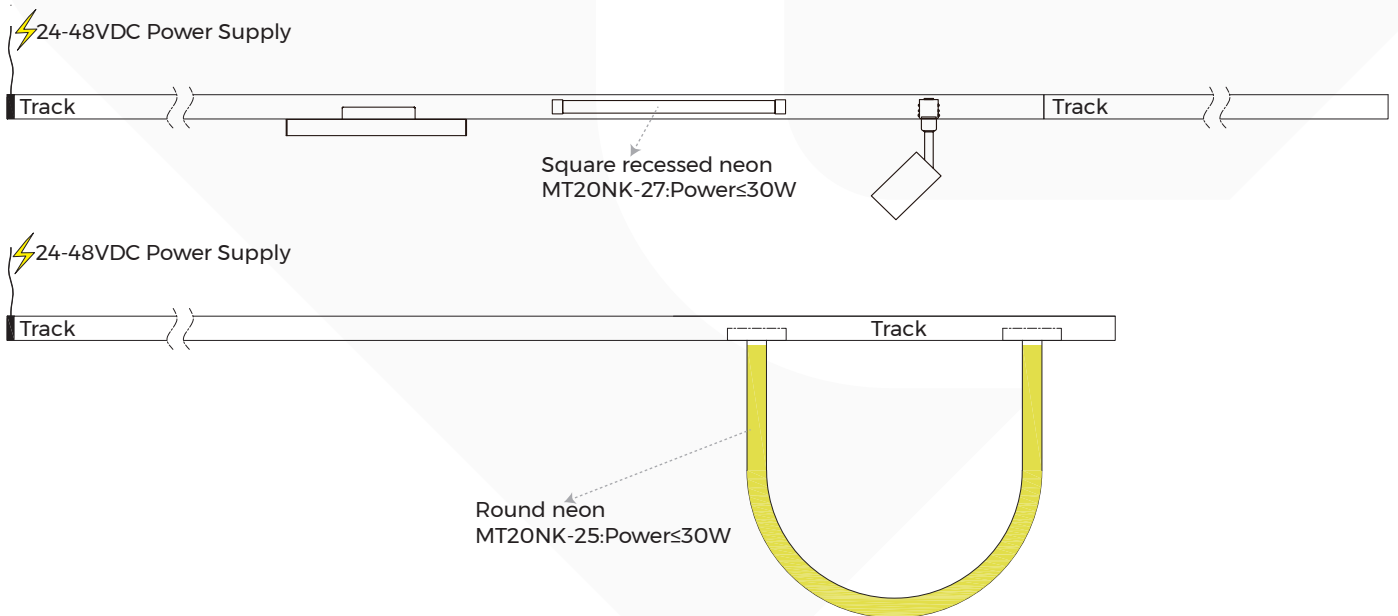

Supplementary power supplies are needed beside the Spotlights module / Decorative module / Linear modular under below one conditions:





1. Power of Square recessed neon MT20NK-27 > 30W
2. Power of Round neon MT20NK-25 > 30W
3. If a DC24V-48V power supply is used to power the track, then only luminaire modules with an input voltage of DC24V-48V can be selected.
4. If a DC48V power supply is used to power the track, then a luminaire module with an input voltage of DC24V-48V or DC48V can be selected.

©MagTrack 20 Product Accessories Information

Picture	Name	Model
	Trimless recessed track (9.5mm gypsum board)	TLS-MR2X0(A)
	Trimless recessed track (12.5mm gypsum board)	TLS-MR2X0(B)
	Trimless recessed track (Ordinary batching)	TLS-MR2X0(C)
	Pendant / Ceiling track	TLS-MS2X0
	Pendant / Ceiling track	TLS-MH2X0
	φ800mm 90° Trimless recessed curve track (9.5mm gypsum board)	TLS-MR208A90(A)
	φ1000mm 90° Trimless recessed curve track (9.5mm gypsum board)	TLS-MR210A90(A)
	φ1200mm 90° Trimless recessed curve track (9.5mm gypsum board)	TLS-MR212A90(A)
	φ800mm 90° Trimless recessed curve track (12.5mm gypsum board)	TLS-MR208A90(B)
	φ1000mm 90° Trimless recessed curve track (12.5mm gypsum board)	TLS-MR210A90(B)
	φ1200mm 90° Trimless recessed curve track (12.5mm gypsum board)	TLS-MR212A90(B)
	φ800mm 90° Ceiling/pendant curve track	TLS-MH208A90
	φ1000mm 90° Ceiling/pendant curve track	TLS-MH210A90
	φ1200mm 90° Ceiling/pendant curve track	TLS-MH212A90

Picture	Name	Model
	Power feeder of track	TLS-M261
	Electrical connector	TLS-M264
	I-shaped electrical connector (Recessed type)	TLS-M265
	I-shaped electrical connector (Surface)	TLS-M266
	End caps	EC-MR20
	End caps	EC-MS20
	End caps	EC-MH20
	Track blind cover	CV-M20FB
	Ceiling accessory	TLS-M271
	Pendant rope set	TLS-M272
	Ceiling screw	CL-01

Picture	Name	Model
	L-shaped corner (Downward)	L90-MR20(A)
	L-shaped corner (Inward)	L90N-MR20(A)
	L-shaped corner (Downward)	L90-MR20(B)
	L-shaped corner (Inward)	L90N-MR20(B)
	L-shaped corner (Downward)	L90-MR20(C)
	L-shaped corner (Inward)	L90N-MR20(C)
	L-shaped corner (Downward)	L90-MS20
	L-shaped corner (Inward)	L90N-MS20
	L-shaped corner (Downward)	L90-MH20
	L-shaped corner (Inward)	L90N-MH20
	L-shaped Adjustable corner (Downward)	L90-MH20(A)
	T-shaped Adjustable corner (Downward)	T90-MH20(A)
	X-shaped Adjustable corner (Downward)	X90-MH20(A)

Picture	Name	Model
	CASAMBI controller	1200EN1812-CAS-XX-BLDAV48
	Magnetic power supply (48V/100W)	MT20-HDRV100H48S-M
	Magnetic power supply (48V/200W)	MT20-HDRV200H48S-M
	48V Constant Voltage Power supply	BN-V48-XXXP

Note:

- 1,Please refer to the accessory list table for detailed parameters.
- 2,Different tracks need to be used with corresponding accessories

©MagTrack 20 Product Economical Accessories Information

Picture	Name	Model
	Trimless recessed track (Ordinary batching)	TLS-ECO-MR2X0
	Trimless recessed track (12.5mm gypsum board)	TLS-ECO-MR2X0(A)
	Pendant / Ceiling track	TLS-ECO-MS2X0
	Pendant / Ceiling track	TLS-ECO-MH2X0
	End caps	EC-ECO-MS20
	End caps	EC-ECO-MH20
	L-shaped corner (Inward)	L90-ECO-MS20
	L-shaped corner (Inward)	L90-ECO-MH20
	Pendant rope set	TLS-ECO-M280
	I-shaped electrical connector (Surface)	TLS-ECO-M281

Note:

1,Please refer to the accessory list table for detailed parameters.

2,Different tracks need to be used with corresponding accessories

◎ NeonTrack Application

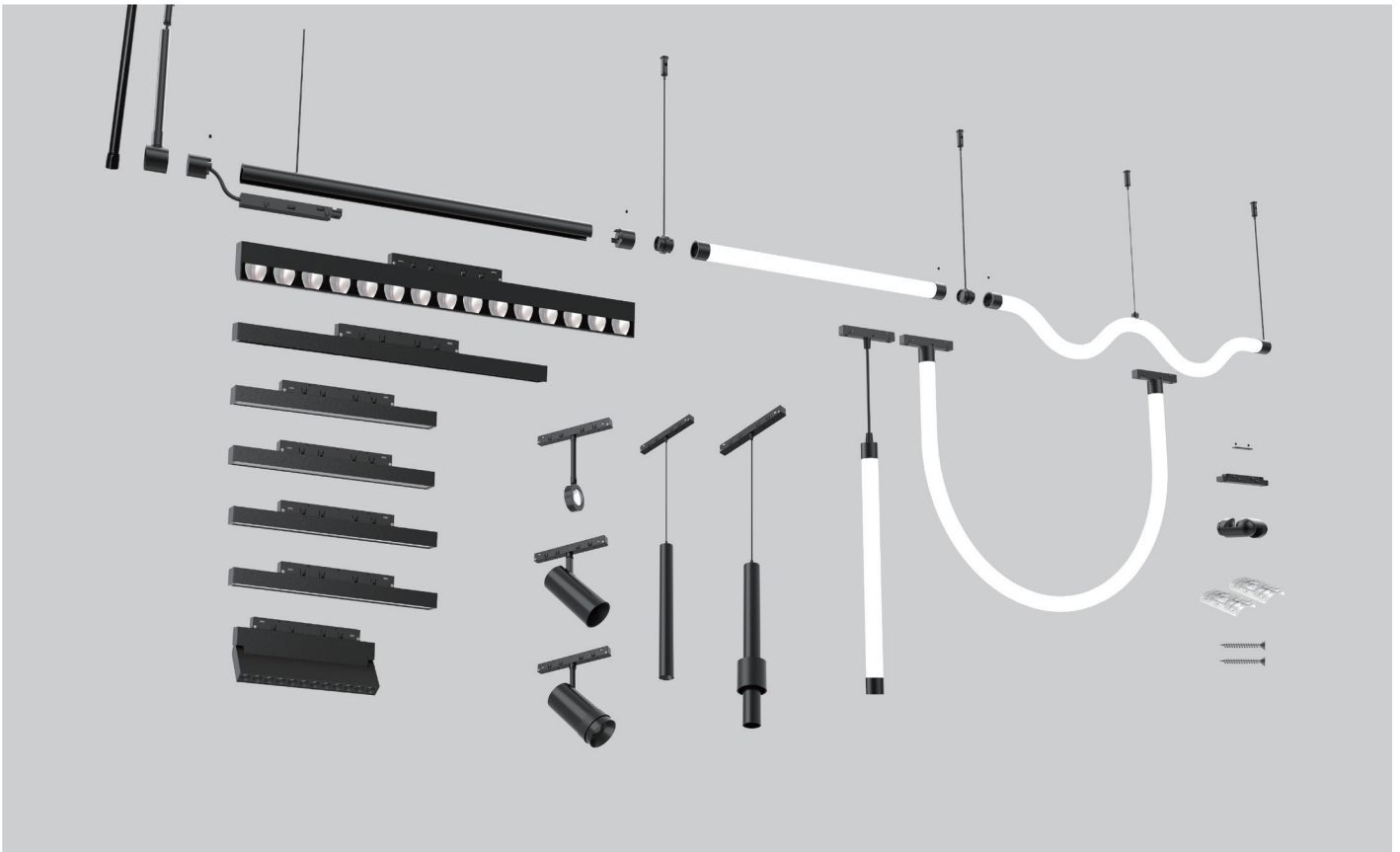

◎ Points to note

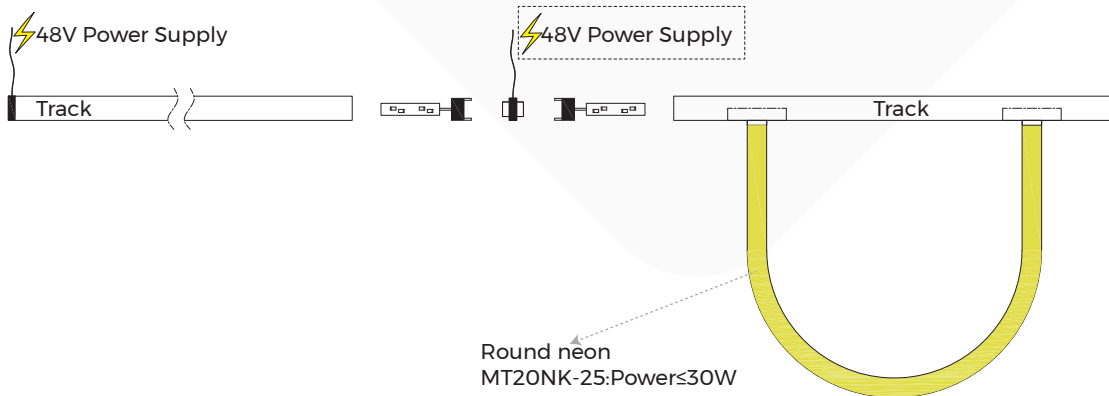
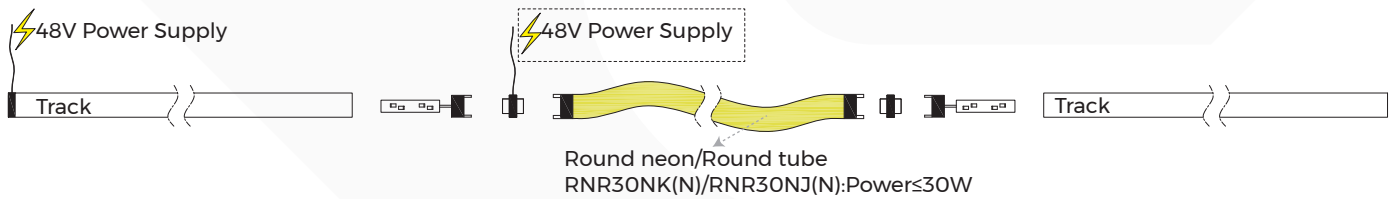
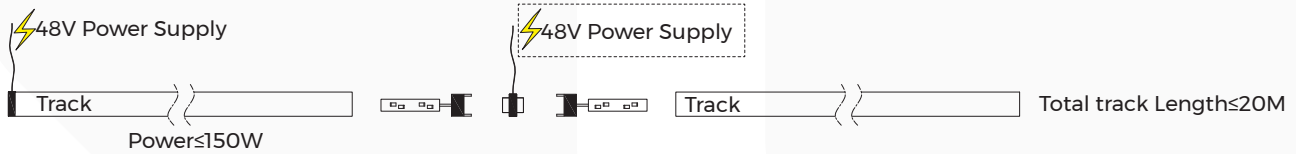





Supplementary power supplies are needed beside the Spotlights module / Decorative module / Linear modular under below one conditions:

1. Load $> 150W$ on the track or Total track length $> 20M$
2. Power of Round neon/Round tube $> 30W$

© NeonTrack Product Accessories Information

Picture	Name	Model
	Round track	TLS-R6X0
	End cap	TLS-R600
	Turned connector	TLS-R860
	Straight connector	TLS-R861
	Power feeder of track	TLS-R862 (N)
	I-shaped electrical connector	TLS-R863 (N)
	Female end cap	TLS-R865
	Ceiling screw	CL-21
	Track pendant rod	PG-I
	Track pendant cable	PN-D

Picture	Name	Model
	Ceiling accessories	CL-18
	Pendant accessories	TLS-R892
	Neon lights Pendant rod (1-2 Meter Adjustable)	TLS-R893
	Neon lights Pendant rod (0.5-1 Meter Adjustable)	TLS-R895
	48V Constant Voltage Power supply	BN-V48-XXXP

Note:

- 1, Please refer to the accessory list table for detailed parameters.
- 2, Different tracks need to be used with corresponding accessories

◎Packing

Model	Size (mm/box)	Quantity /box	Quantity /carton	NW (kg/box)	NW (kg/carton)	GW (kg)	Size (mm/carton)
TLS-MT20G0110-06904030-NBB	310*48*30 [4.37"*0.88"*4.09"]	1	30	0.12	3.6	4.5	630*154*160 [24.8"*6.06"*6.3"]
TLS-MT20G0220-12904030-NBB	310*48*30 [4.37"*0.88"*4.09"]	1	30	0.17	5.1	6	630*154*160 [24.8"*6.06"*6.3"]
TLS-MT20G0440-24904030-NBB	610*48*30 [8.62"*0.88"*4.09"]	1	15	0.27	4.05	5.1	630*154*160 [24.8"*6.06"*6.3"]

◎Model Code

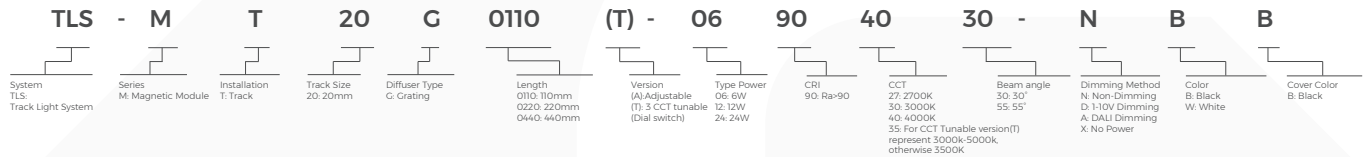

◎Attentions

- 1、 Non-professionals are prohibited from installing, disassembling and repairing the product.
- 2、 Avoid scratching, distortion and irregular bending of the product during installation; otherwise it may cause irreparable damage to the product.
- 3、 Please use professional cutting tools when cutting
- 4、 Do not use any acid or alkaline adhesive to fix products
- 5、 The product is only suitable for indoor dry places, can not be used in outdoor, seaside or wet environment.
- 6、 PC features: Each 10°C rise or drop will make diffuser extend or shrink 0.8mm/m, please confirm before processing and use